

- ✓ cichszy
- ✓ wydajniejszy
- ✓ bardziej oszczędny
- ✓ kompaktowy

AŻ DO 50% LEPSZY



zewnątrzni pierścień wirnika
doszczelniający obudowę na połączeniu z wlotem i dyfuzorem redukuje straty przepływu



konfuzor wlotowy
redukuje zawirowania strugi między obudową a krawędziami łopatek



dyfuzor
wyrównujący prędkości przepływu w całym przekroju kanału za wentylatorem



kierownice dyfuzora
o unikalnym profilu ograniczają burzliwość przepływu za wirnikiem

konstrukcja

Diagonalny wentylator kanałowy. Obudowa wykonana z blachy stalowej cynkowanej galwanicznie, dla średnicy 200 z tworzywa w kolorze czarnym, a od średnicy 400 włącznie – w całości z aluminium. Unikalny konfuzor wlotowy dostosowany dokładnie do wymiarów wirnika sprawia, że powietrze jest zaciągane bezpośrednio na stożek wirnika diagonalnego bez zawirowań strugi między obudową a krawędziami łopatek. Przed utratą sprawności na krawędziach łopatek chroni również specjalny profilowany pierścień łączący wszystkie łopatki i doszczelniający komorę przepływu pomiędzy konfuzorem a kierownicami dyfuzora znajdującego się za wirnikiem.

Silnik został obudowany profilem dyfuzora wykonanym z tworzywa sztucznego, którego głównymi elementami są profilowane kierownice mające za zadanie maksymalne ograniczenie burzliwości przepływu za wirnikiem oraz ścięty stożek wyrównujący prędkości przepływu w całym przekroju kanału za wentylatorem. Takie połączenie różnych elementów regulacji strumienia powietrza sprawia, że efektywność pracy wentylatora wzrosła o około 50% w stosunku do standardowych wentylatorów z wirnikami promieniowymi.

wirnik

Wyważany dynamicznie wirnik diagonalny z tworzywa sztucznego (od średnicy 400 z aluminium) z pierścieniem zewnętrznym eliminującym straty ciśnienia wywołane turbulentnym przepływem na końcach łopatek. Łopatki profilowane w celu zachowania jak najmniej turbulentnego przepływu, umieszczone na stożkowej piaście konfuzora, dzięki któremu zasysane powietrze kierowane jest na najbardziej efektywną część łopatki.

naped i sterowanie

Asynchroniczny silnik elektryczny jednofazowy 230V, 50Hz lub trójfazowy 3 x 230V, oraz 3 x 400V, 50Hz. Silniki posiadają zintegrowane zabezpieczenie termiczne (z resetem manualnym: modele od 200/900S do 400/3400S),

pozostałe modele posiadają wbudowany czujnik temperatury uzwojeń, którego końcówki muszą być podłączone do zewnętrznego przełącznika ochrony termicznej np. typu S ET10 lub STD1 16. Silniki jednofazowe przystosowane są do napięciowej regulacji prędkości obrotowej w zakresie 80-230V za pomocą regulatorów transformatorowych. Silniki trójfazowe przystosowane są do zasilania i regulacji za pomocą przemiennika częstotliwości. Stopień ochrony wentylatorów IPX4, klasa izolacji F.

maksymalna temperatura pracy

40 ÷ 80°C – w zależności od wybranego modelu.

zastosowanie

Transport czystego, niezapyłonego powietrza w instalacjach wentylacyjnych do i z pomieszczeń w obiektach: mieszkalnych, biurowych, przemysłowych i użyteczności publicznej. Element nawiewu w centralach wentylacyjnych, współpraca z wymiennikami ciepła.



JETTEC 400 ÷ 710

Modele standardowo wykonane w całości z aluminium

OSZCZĘDNOŚĆ ENERGII



Dzięki unikalnym rozwiązaniom redukującym straty przepływu, JETTEC osiąga efektywność do 50% większą od standardowych wentylatorów kanałowych oraz do 30% mniejsze zużycie energii. Dzięki temu wentylator jest przyjazny dla środowiska, jego zastosowanie gwarantuje redukcję kosztów eksploatacyjnych, a zastosowane sterowniki i zabezpieczenia mogą być mniejsze niż w standardowych projektach.

OSZCZĘDNOŚĆ PRZESTRZENI



Unikalna konstrukcja wirnika i dyfuzora sprawia, że możliwe było zastosowanie obudowy na całej swej długości dokładnie odpowiadającej średnicy przewodu, w którym ma być zainstalowany wentylator. Dzięki temu można projektować instalacje zajmujące mniej cennego miejsca.

OSZCZĘDNOŚĆ PIENIĘDZY



Od 75% do 90% całkowitych kosztów związanych z zainstalowanym wentylatorem, to koszty energii elektrycznej zużytej w czasie eksploatacji. Można je zredukować nawet o 30% instalując wentylatory JETTEC. Wentylatory JETTEC w stosunku do swych parametrów są relatywnie tanie w porównaniu ze standardowymi rozwiązaniami.

tablica doboru akcesoriów dla danego wentylatora JETTEC

Typ JETTEC	250/1600S	250/1700S	280/2300S	315/2300S	315/3500S	355/2600S	355/5000S
wyłącznik serw.	GS 01	GS 01	GS 01	GS 01	GS 01	GS 01	GS 01
5-bieg. reg. tran.	STR-1-15L22	STR-1-15L22	STR-1-22L22	STR-1-22L22	STR-1-35L22	STR-1-22L22	STR-1-75L22
autotransf.	ATR-15-L25	ATR-15-L25	ATR-1-25L25	ATR-1-25L25	ATR-1-35L25	ATR-1-25L25	ATR-1-75L25
klamra montaż.	OFK 250	OFK 250	OFK 280	OFK 315	OFK 315	OFK 355	OFK 355
tłumik prosty	SDS 250	SDS 250	-	SDS 315	SDS 315	SDS 355	SDS 355
tłumik elast.	FLEXITEC 250	FLEXITEC 250	-	FLEXITEC 315	FLEXITEC 315	-	-
siatka ochr.	SG-2 250	SG-2 250	SG-2 280	SG-2 315	SG-2 315	SG-2 355	SG-2 355
klapa zwrotna	RSK 250	RSK 250	-	RSK 315	RSK 315	RSK 355	RSK 355
filtr EU3	FBM 200	FBM 250	-	FBM 315	FBM 315	FBM 315	FBM 355
kaseta filtra	FBB 250	FBB 250	-	FBB 315	FBB 315	FBB 355	FBB 355
przepustnica Iris	IRIS 250	IRIS 250	-	IRIS 315	IRIS 315	-	-

Typ JETTEC	400/3400S	450/5000S	500/6700S	560/9600S	630/14000S	250/2400F	315/4300F	355/5100F
wyłącznik serw.	GS 01	GS 01	GS 01	GS 01	GS 01	GS 03	GS 03	GS 03
5-bieg. reg. tran.	STR-1-22L22	-	-	-	-	-	-	-
5-bieg. reg. Tran. TK	-	STRS-1-50L22	STRS-1-50L22	STRS-1-100L22	STRS-1-130L22	-	-	-
autotransf.	ATR-1-25L25	ATR-1-50L25	ATR-1-50L25	ATR-1-100L25	ATR-1-130L25	-	-	-
przebiegnik częstotliwości	-	-	-	-	-	SV004iCS-1F (1x230/3x230)	SV008iCS-1F (1x230/3x230)	SV015iCS-1F (1x230/3x230)
klamra montaż.	OFK 400	OFK 450	OFK 500	OFK 560	OFK 630	OFK 250	OFK 315	OFK 355
tłumik prosty	SDS 400	-	SDS 500	-	-	SDS 250	SDS 315	SDS 355
tłumik elast.	-	-	-	-	-	FLEXITEC 250	FLEXITEC 315	-
siatka ochr.	SG-2 400	SG-2 450	SG-2 500	-	-	SG-2 250	SG-2 315	SG-2 355
klapa zwrotna	RSK 400	-	-	-	-	RSK 250	RSK 315	RSK 355
filtr EU3	FBM 400	-	-	-	-	FBM 250	FBM 315	FBM 355
kaseta filtra	FBB 400	-	-	-	-	FBB 250	FBB 315	FBB 355
przepustnica Iris	IRIS 400	-	IRIS 500	-	IRIS 630	IRIS 250	IRIS 315	-

Typ JETTEC	400/5200F	400/6900F	450/7300F	500/9900F	560/10800F	630/16300F	710/23100F
wyłącznik serw.	GS 03	GS 03	GS 03	GS 03	GS 03	GS 03	GS 03
5-bieg. reg. tran.	-	-	-	-	-	-	-
5-bieg. reg. Tran. TK	-	-	-	-	-	-	-
autotransf.	-	-	-	-	-	-	-
przebiegnik częstotliwości	SV008iCS-1F (1x230/3x230)	SV022iG5A-4 (3x400/3x400)	SV015iCS-1F (1x230/3x230)	SV022iCS-1F (1x230/3x230)	SV015iG5A-4 (3x400/3x400)	SV022iG5A-4 (3x400/3x400)	SV055iG5A-4 (3x400/3x400)
klamra montaż.	OFK 400	OFK 400	OFK 450	OFK 500	OFK 560	OFK 630	OFK 710
tłumik prosty	SDS 400	SDS 400	-	SDS 500	-	-	-
siatka ochr.	SG-2 400	SG-2 400	SG-2 450	SG-2 500	-	-	-
klapa zwrotna	RSK 400	RSK 400	-	-	-	-	-
filtr EU3	FBM 400	FBM 400	-	-	-	-	-
kaseta filtra	FBB 400	FBB 400	-	-	-	-	-
przepustnica Iris	IRIS 400	IRIS 400	-	IRIS 500	-	IRIS 630	-

Akcesoria

-  **GS**
wyłącznik serwisowy
str. nr 548
-  **STR-1**
5-bieg. reg. ob. (transformatorowy)
str. nr 533
-  **ATR-1**
autotransf. do zab. w szafie ster.
str. nr 532
-  **OFK**
klamra montażowa
str. nr 94
-  **SDS**
tłumik kanałowy prosty
str. nr 97
-  **FLEXITEC**
tłumik kanałowy elastyczny
str. nr 96
-  **SG-2**
siatka ochronna
str. nr 97
-  **RSK**
klapa zwrotna
str. nr 94
-  **FBM**
filtr kanałowy EU3
str. nr 93
-  **FBB**
kaseta filtra kieszeniowego
str. nr 93
-  **IRIS**
przepustnica soczewkowa
str. nr 95
-  **iCS/iG5A**
przebiegnik częstotliwości
str. nr 550
-  **STRS-1**
5-bieg. reg. ob. (transformator.) TK
str. nr 533
-  **URK**
płyta adaptacyjna
str. nr 102

schematy elektryczne

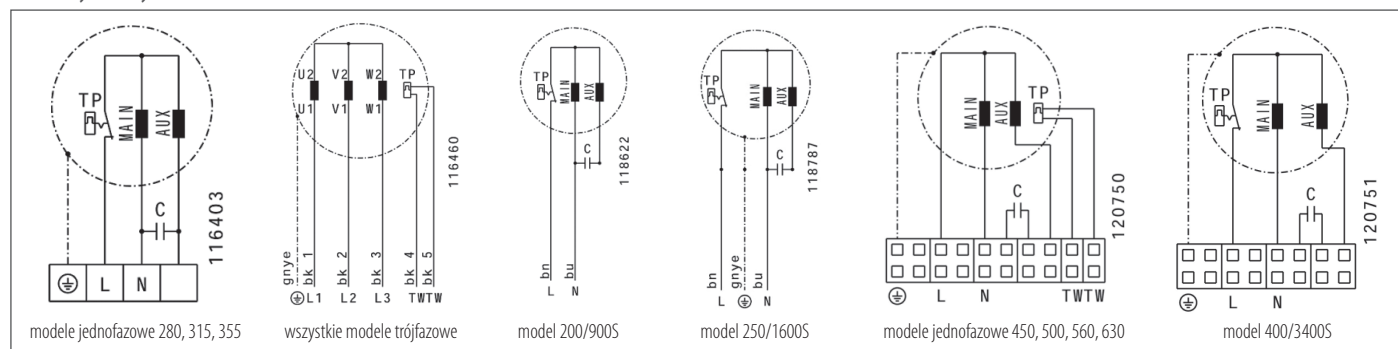

dane techniczne

Typ	\dot{V}_{max} [m³/h]	Δp_{max} [Pa]	P_{max} [W]	U [V]	I_{max} [A]	f_n [Hz]	f_{max} [Hz]	RPM _{max} [1/min]	t_{max} [°C]	L_{WA} [dB(A)]	L_{pA} [dB(A)]	m [kg]	nr katalogowy
JETTEC 250/1600S	1623	450	160	230	0,8	50	-	2810	50	49	42	5,3	11622700
JETTEC 250/1700S	1740	470	180	230	1,0	50	-	2890	55	54	47	6,4	11238200
JETTEC 280/2300S	2350	570	270	230	1,6	50	-	2880	55	57	50	8,3	11533400
JETTEC 315/2300S	2350	570	270	230	1,6	50	-	2880	55	57	50	8,4	11701000
JETTEC 315/3500S	3510	760	530	230	3,2	50	-	2850	70	61	54	14,2	11220200
JETTEC 355/2600S	2580	270	150	230	1,0	50	-	1460	80	48	41	13,5	11236900
JETTEC 355/5000S	4940	930	960	230	5,4	50	-	2850	45	63	56	17,3	11275700
JETTEC 400/3400S	3440	310	215	230	1,5	50	-	1460	80	61	54	12,8	11938000
JETTEC 450/5000S	5220	425	450	230	3,1	50	-	1450	80	66	59	18,4	11933600
JETTEC 500/6700S	6950	490	740	230	4,2	50	-	1400	80	68	61	23,2	11806100
JETTEC 560/9600S	9550	630	1120	230	7,6	50	-	1430	80	79	72	38,0	11934900
JETTEC 630/14000S	14000	775	2140	230	11,4	50	-	1410	50	77	70	43,1	11932400
JETTEC 250/2400F	2380	900	380	3*230	1,5	65	70	3980	50	65	58	6,6	11898000
JETTEC 315/4300F	4210	1160	560	3*230	3,0	50	60	3490	40	70	63	15,5	11275900
JETTEC 355/5100F	5000	960	920	3*230	3,2	50	50	2910	60	67	60	17,5	11276000
JETTEC 400/5200F	5160	730	660	3*230	2,7	75	75	2200	80	68	61	14,8	11937700
JETTEC 400/6900F	6910	1284	1570	3*400	3,2	50	50	2930	80	82	75	20,3	11967700
JETTEC 450/7300F	7345	860	1000	3*230	4,4	70	75	2150	80	72	65	18,9	11857000
JETTEC 500/9900F	9850	1030	1930	3*230	7,1	70	70	2060	70	79	72	23,6	11758000
JETTEC 560/10800F	10800	790	1445	3*400	2,7	50	55	1610	60	78	71	33,0	14653700
JETTEC 630/16300F	16250	990	2745	3*400	5,1	50	55	1600	60	77	70	49,5	14653400
JETTEC 710/23100F	23140	1230	5123	3*400	9,8	50	55	1610	60	85	78	63,0	14653100

wymiary

Typ	A [mm]	B [mm]	C [mm]	ØD [mm]
JETTEC 250/1600S	254±1	214,5±1	258,8±2	250±1
JETTEC 250/1700S	296±2	278±1	258,8±2	250±1
JETTEC 280/2300S	320,9±2	307,6±1	289,5±2	280,7±1
JETTEC 315/2300S	335,5±2	307,6±1	318,5±2	315
JETTEC 315/3500S	349±2	350,7±1	323,8±2	315±1
JETTEC 355/2600S	388,3±2	396±1	362,5±2	353,5±1
JETTEC 355/5000S	388,3±2	396±1	362,5±2	353,5±1
JETTEC 400/3400S	352±2	416±3	431,8±2	403
JETTEC 450/5000S	402±2	466,5±3	466,8±2	452,6
JETTEC 500/6700S	442,6±2	515±3	512,2±2	503,7
JETTEC 560/9600S	513±2	582±3	573±2	564
JETTEC 630/14000S	583,4±2	653,5±3	643,2±2	634,4
JETTEC 250/2400F	296±2	278±1	258,8±2	250±1
JETTEC 315/4300F	319±1	350,7±1	329,8±2	315±1
JETTEC 355/5100F	357,5±1	396±1	362,5±2	353,5±1
JETTEC 400/5200F	352±2	416±3	431,8±2	403
JETTEC 400/6900F	352±2	416±3	431,8±2	403

Typ	A [mm]	B [mm]	C [mm]	ØD [mm]
JETTEC 450/7300F	357±2	466,4±3	466,8±2	452,6
JETTEC 500/9900F	397,7±2	515±3	512,2±2	503,7
JETTEC 560/10800F	568 ±2	582 ±3	573 ±2	564 ±1
JETTEC 630/16300F	638 ±2	654 ±3	638 ±2	634 ±1
JETTEC 710/23100F	717 ±2	732 ±3	723 ±2	714 ±1

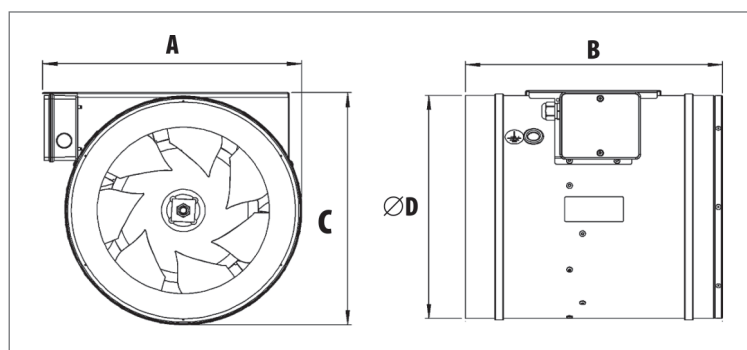

charakterystyki pracy

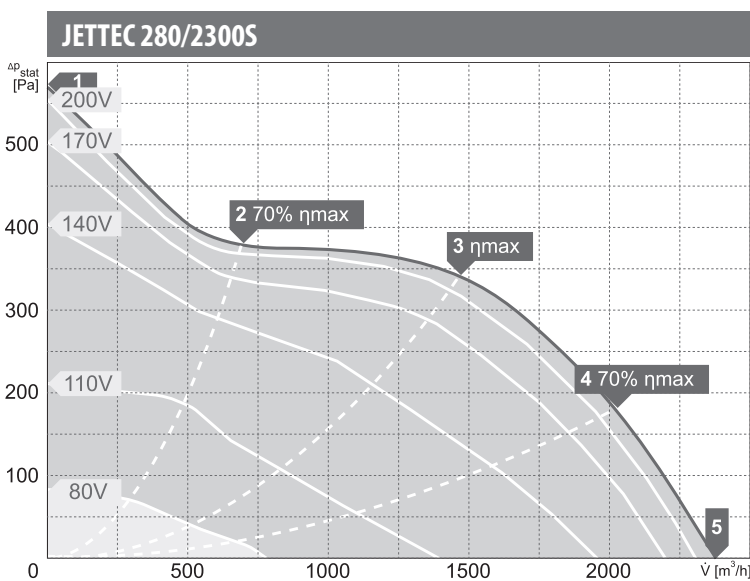
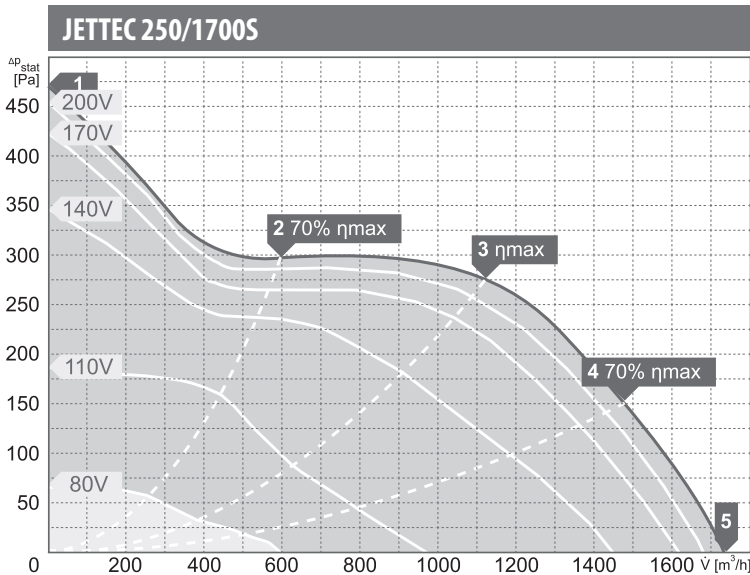
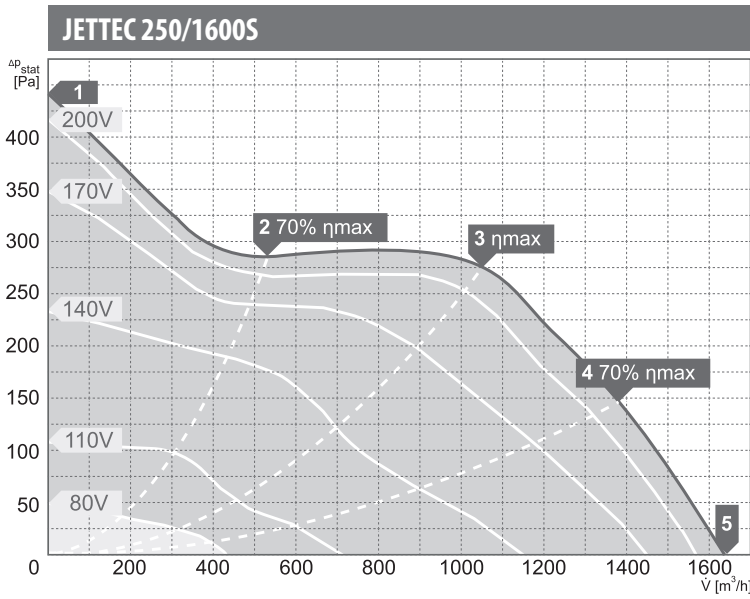

wartości mocy akustycznej L_{WA} [dB(A)]
dla poszczególnych częstotliwości pasm oktaowych [Hz]

Pkt. Pracy	tot	Częstotliwości pasm oktaowych [Hz]							
		63	125	250	500	1000	2000	4000	8000
L_{WA} wlot [dB(A)]									
2	74	-	61	65	70	69	67	63	56
3	70	-	36	47	57	63	66	67	56
4	72	-	40	52	60	64	66	68	57
5	74	-	42	56	63	66	68	70	60
L_{WA} wylot [dB(A)]									
2	78	-	59	64	71	75	73	66	59
3	74	-	41	57	63	69	69	65	54
4	75	-	42	61	65	71	71	67	56
5	77	-	43	63	68	72	73	70	59
L_{WA} od obudowy [dB(A)]									
2	57	-	52	47	42	50	52	48	41
3	49	-	36	35	34	45	44	41	35
4	51	-	36	36	36	46	45	45	38
5	53	-	37	37	37	47	47	47	40

Pkt. Pracy	tot	Częstotliwości pasm oktaowych [Hz]							
		63	125	250	500	1000	2000	4000	8000
L_{WA} wlot [dB(A)]									
2	74	-	58	63	70	70	66	62	55
3	72	-	44	56	64	67	66	63	54
4	72	-	36	55	61	66	67	68	56
5	75	-	39	59	65	68	69	71	60
L_{WA} wylot [dB(A)]									
2	78	-	58	64	72	74	71	65	58
3	78	-	56	64	72	74	71	64	57
4	77	-	40	66	70	72	70	67	56
5	79	-	41	69	72	74	73	70	59
L_{WA} od obudowy [dB(A)]									
2	58	-	50	48	51	52	51	44	41
3	54	-	41	46	47	49	48	42	38
4	53	-	36	47	44	48	47	43	38
5	55	-	38	46	46	49	49	46	40

Pkt. Pracy	tot	Częstotliwości pasm oktaowych [Hz]							
		63	125	250	500	1000	2000	4000	8000
L_{WA} wlot [dB(A)]									
2	77	-	58	66	72	72	69	66	57
3	75	-	49	63	68	70	69	66	57
4	76	-	43	61	67	70	71	71	59
5	79	-	47	66	69	71	72	75	63
L_{WA} wylot [dB(A)]									
2	81	-	61	69	76	77	74	68	61
3	79	-	50	69	73	75	73	66	58
4	81	-	46	70	75	76	74	69	60
5	82	-	48	71	76	78	76	73	63
L_{WA} od obudowy [dB(A)]									
2	62	-	52	49	53	56	55	53	49
3	57	-	44	46	49	53	51	49	45
4	56	-	39	44	48	52	50	48	43
5	58	-	40	45	51	53	52	52	45

charakterystyki pracy

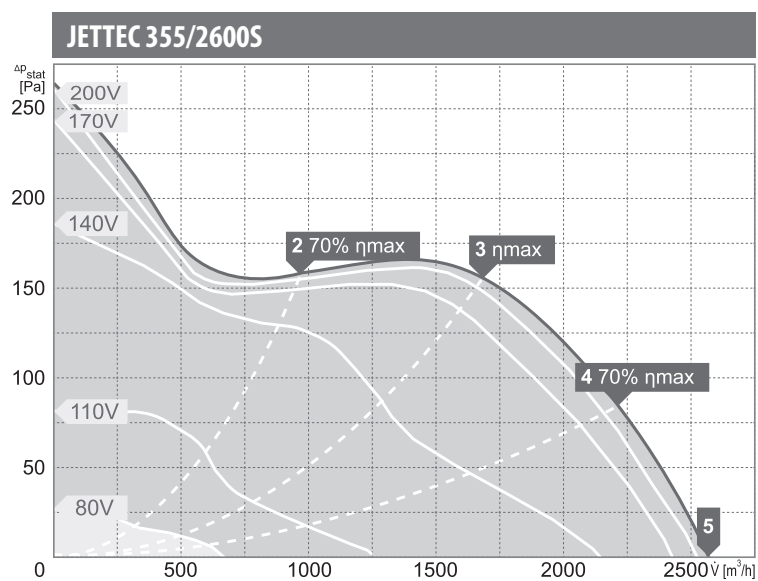
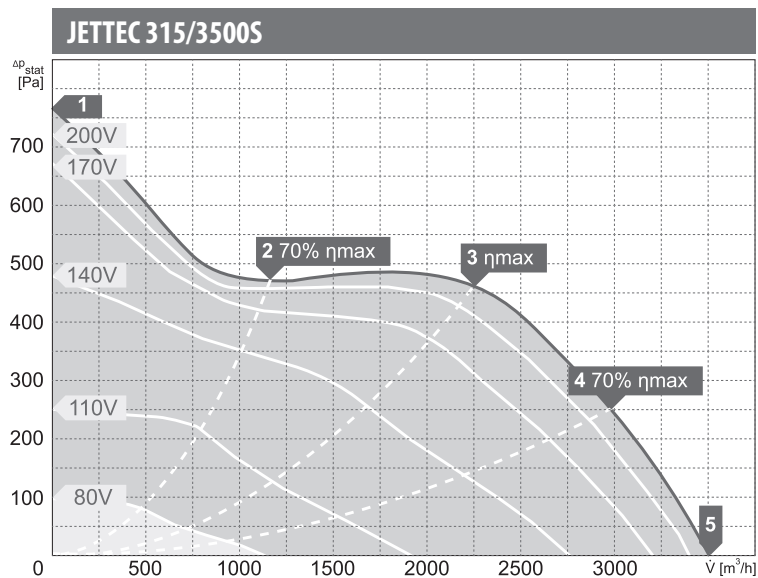
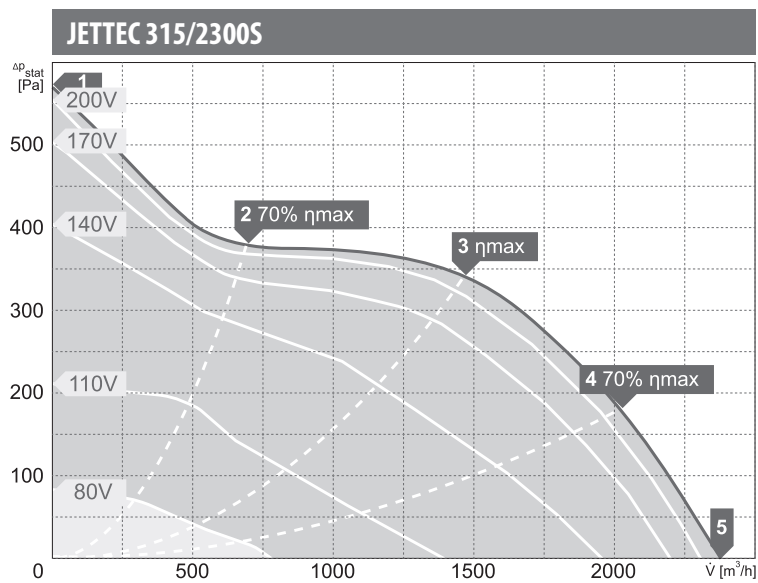

wartości mocy akustycznej L_{WA} [dB(A)]
dla poszczególnych częstotliwości pasm oktaowych [Hz]

Pkt. Pracy	tot	Częstotliwości pasm oktaowych [Hz]							
		63	125	250	500	1000	2000	4000	8000
L_{WA} wlot [dB(A)]									
2	77	-	58	66	72	72	69	66	57
3	75	-	49	63	68	70	69	66	57
4	76	-	43	61	67	70	71	71	59
5	79	-	47	66	69	71	72	75	63
L_{WA} wylot [dB(A)]									
2	81	-	61	69	76	77	74	68	61
3	79	-	50	69	73	75	73	66	58
4	81	-	46	70	75	76	74	69	60
5	82	-	48	71	76	78	76	73	63
L_{WA} od obudowy [dB(A)]									
2	62	-	52	49	53	56	55	53	49
3	57	-	44	46	49	53	51	49	45
4	56	-	39	44	48	52	50	48	43
5	58	-	40	45	51	53	52	52	45

Pkt. Pracy	tot	Częstotliwości pasm oktaowych [Hz]							
		63	125	250	500	1000	2000	4000	8000
L_{WA} wlot [dB(A)]									
2	80	62	70	75	75	73	70	62	51
3	76	48	64	70	70	70	69	66	55
4	78	46	66	70	70	71	71	70	58
5	81	48	71	73	74	74	75	74	61
L_{WA} wylot [dB(A)]									
2	85	66	73	79	81	78	72	64	52
3	82	50	70	75	78	75	71	65	54
4	83	50	73	76	79	77	72	68	57
5	85	50	73	78	80	78	75	70	59
L_{WA} od obudowy [dB(A)]									
2	61	46	50	52	57	55	63	46	37
3	61	44	49	52	56	54	53	47	37
4	61	43	49	54	57	54	53	49	38
5	63	46	51	56	58	55	55	51	39

Pkt. Pracy	tot	Częstotliwości pasm oktaowych [Hz]							
		63	125	250	500	1000	2000	4000	8000
L_{WA} wlot [dB(A)]									
2	68	52	58	63	64	61	55	44	33
3	64	44	55	58	60	57	55	44	35
4	66	46	56	59	60	59	60	46	38
5	69	51	57	61	62	63	63	48	43
L_{WA} wylot [dB(A)]									
2	71	53	60	67	67	62	56	45	32
3	67	53	56	62	63	57	53	40	29
4	69	57	57	64	65	60	57	43	32
5	72	56	60	66	67	64	60	47	39
L_{WA} od obudowy [dB(A)]									
2	52	46	41	44	46	42	40	28	19
3	48	42	39	40	43	39	38	25	18
4	48	41	38	40	43	40	40	24	17
5	52	42	41	43	46	43	46	29	20

charakterystyki pracy

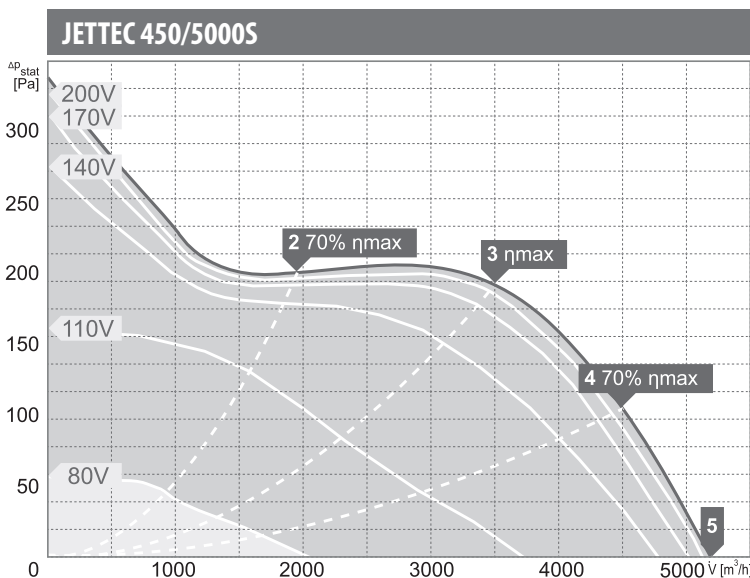
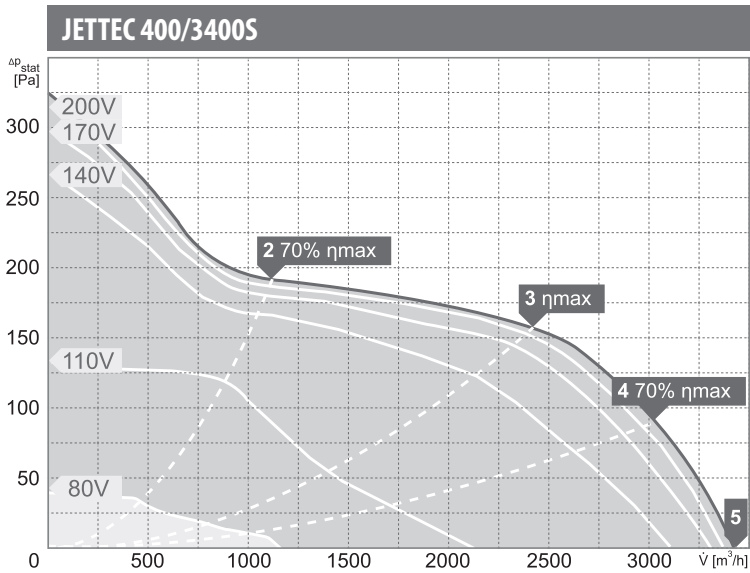
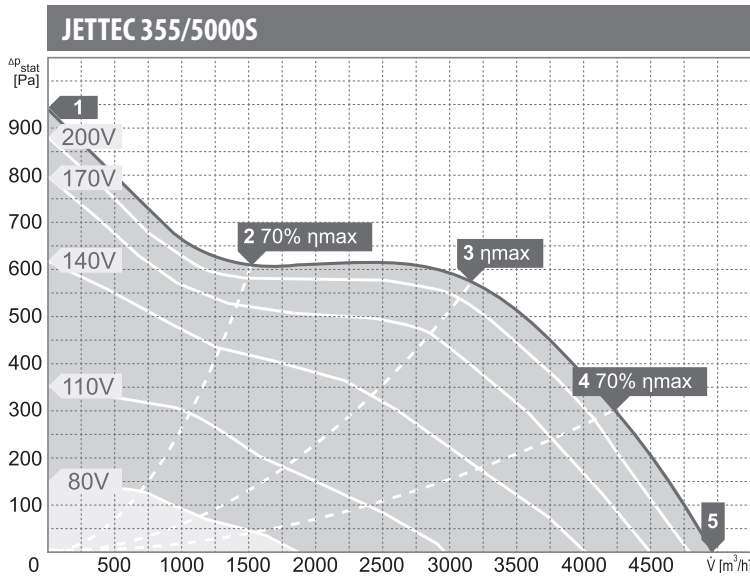

wartości mocy akustycznej L_{WA} [dB(A)]
dla poszczególnych częstotliwości pasm oktaowych [Hz]

Pkt. Pracy	Częstotliwości pasm oktaowych [Hz]								
	tot	63	125	250	500	1000	2000	4000	8000
L_{WA} wlot [dB(A)]									
2	82	58	69	74	78	76	72	63	56
3	79	48	64	70	75	74	71	64	58
4	80	46	67	70	76	75	73	67	59
5	84	49	72	74	79	78	77	71	62
L_{WA} wylot [dB(A)]									
2	84	54	70	76	80	77	72	64	55
3	84	54	69	77	80	78	73	65	56
4	85	54	72	78	81	79	74	67	57
5	87	55	74	80	83	81	77	69	58
L_{WA} od obudowy [dB(A)]									
2	64	47	56	54	59	57	55	44	39
3	63	46	55	55	59	56	55	45	39
4	64	47	56	56	59	57	56	46	40
5	67	48	56	60	61	59	58	49	42

Pkt. Pracy	Częstotliwości pasm oktaowych [Hz]								
	tot	63	125	250	500	1000	2000	4000	8000
L_{WA} wlot [dB(A)]									
2	74	52	64	71	67	64	58	47	26
3	70	48	56	67	64	63	57	47	25
4	73	55	59	68	67	68	63	52	30
5	75	57	60	70	68	69	64	53	31
L_{WA} wylot [dB(A)]									
2	77	60	67	74	72	66	61	50	29
3	75	60	60	71	70	64	59	49	27
4	77	65	63	72	72	68	64	53	31
5	78	65	63	73	73	69	65	54	32
L_{WA} od obudowy [dB(A)]									
2	63	51	46	59	59	51	49	38	15
3	61	48	44	58	56	48	47	37	13
4	63	50	46	59	59	53	52	40	16
5	63	50	46	59	58	53	52	40	16

Pkt. Pracy	Częstotliwości pasm oktaowych [Hz]								
	tot	63	125	250	500	1000	2000	4000	8000
L_{WA} wlot [dB(A)]									
2	77	61	69	71	72	69	64	53	34
3	71	54	62	65	67	65	59	50	31
4	76	57	63	66	69	73	63	54	36
5	78	64	66	69	71	74	68	57	39
L_{WA} wylot [dB(A)]									
2	81	65	72	77	76	71	67	56	36
3	76	64	65	72	72	67	62	51	31
4	79	68	66	73	74	72	65	55	35
5	81	70	69	76	76	74	69	59	39
L_{WA} od obudowy [dB(A)]									
2	68	54	62	65	62	54	51	39	15
3	66	52	59	61	62	56	50	39	16
4	70	56	64	65	63	59	53	41	18
5	72	57	69	67	65	61	57	43	21

charakterystyki pracy

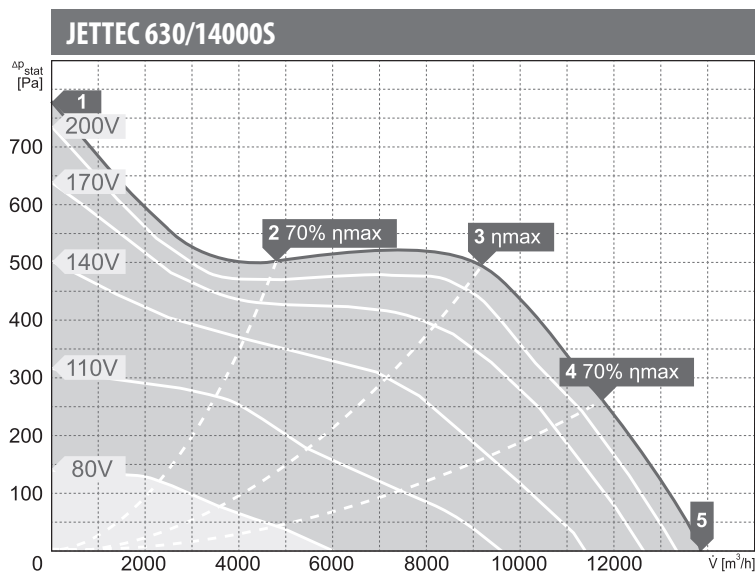
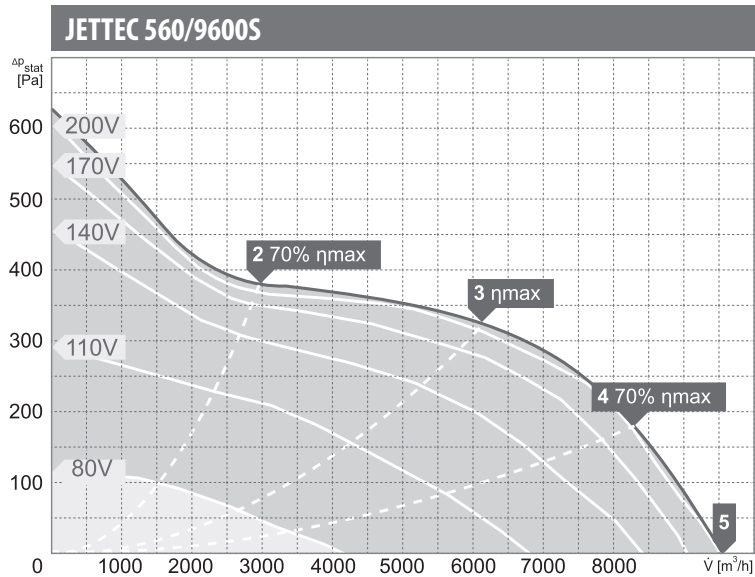
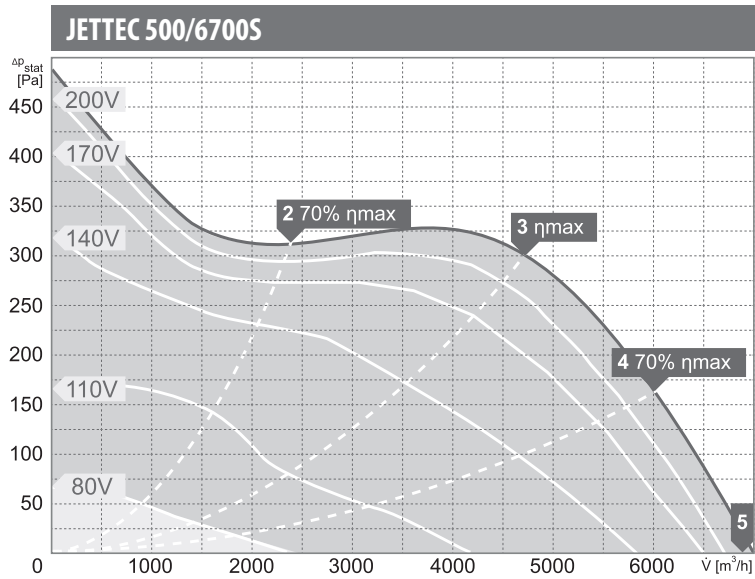

wartości mocy akustycznej L_{WA} [dB(A)]
dla poszczególnych częstotliwości pasm oktaowych [Hz]

Pkt. Pracy	tot	Częstotliwości pasm oktaowych [Hz]							
		63	125	250	500	1000	2000	4000	8000
L_{WA} wlot [dB(A)]									
2	79	66	73	73	73	71	65	55	44
3	75	64	66	69	70	68	62	53	42
4	77	65	67	71	71	72	66	55	45
5	79	69	69	72	73	73	69	57	47
L_{WA} wylot [dB(A)]									
2	82	69	75	78	77	73	68	58	46
3	83	76	73	78	77	73	67	57	45
4	83	75	73	77	77	74	68	58	46
5	83	74	75	78	77	74	70	58	46
L_{WA} od obudowy [dB(A)]									
2	72	56	66	67	66	61	56	44	23
3	68	55	65	63	60	55	51	39	19
4	69	54	65	63	61	57	56	39	17
5	71	54	66	65	64	61	59	42	22

Pkt. Pracy	tot	Częstotliwości pasm oktaowych [Hz]							
		63	125	250	500	1000	2000	4000	8000
L_{WA} wlot [dB(A)]									
2	84	68	79	79	77	76	69	58	38
3	83	69	77	78	75	74	68	59	38
4	83	69	77	78	76	75	70	60	42
5	85	72	77	79	79	78	74	63	45
L_{WA} wylot [dB(A)]									
2	88	71	81	85	81	76	71	61	41
3	87	71	80	83	78	75	70	60	40
4	87	75	81	83	80	77	73	63	44
5	87	76	82	84	81	79	76	65	46
L_{WA} od obudowy [dB(A)]									
2	81	69	78	77	69	65	58	50	25
3	79	68	76	75	67	64	58	50	25
4	79	68	76	74	68	67	61	52	26
5	81	70	77	75	69	68	63	52	26

Pkt. Pracy	tot	Częstotliwości pasm oktaowych [Hz]							
		63	125	250	500	1000	2000	4000	8000
L_{WA} wlot [dB(A)]									
2	89	-	72	79	84	83	81	75	66
3	84	-	69	75	80	78	75	68	61
4	86	-	71	76	81	80	78	76	64
5	88	-	74	78	82	82	80	78	66
L_{WA} wylot [dB(A)]									
2	90	-	73	81	86	84	81	76	65
3	86	-	72	78	83	80	77	73	62
4	88	-	73	80	84	82	79	76	65
5	90	-	74	82	86	84	81	78	67
L_{WA} od obudowy [dB(A)]									
2	81	-	68	74	77	73	70	60	51
3	77	-	67	73	72	68	66	60	49
4	78	-	68	74	73	70	68	64	51
5	80	-	70	75	76	72	70	66	53

charakterystyki pracy

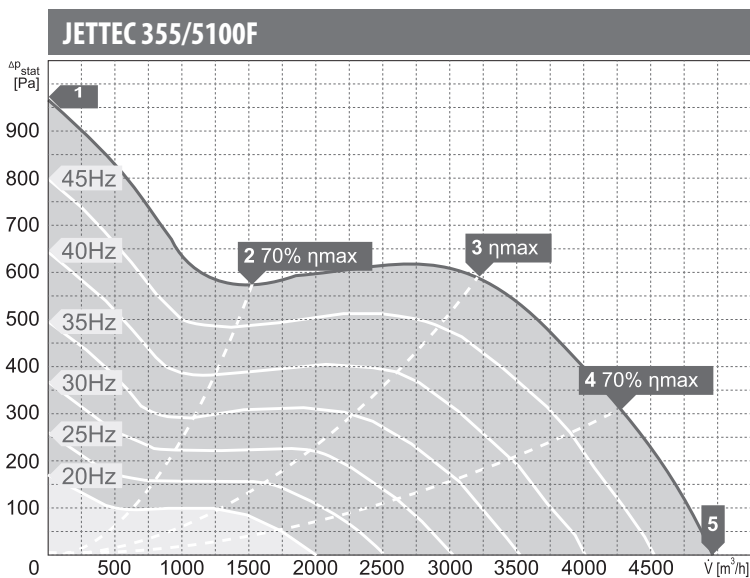
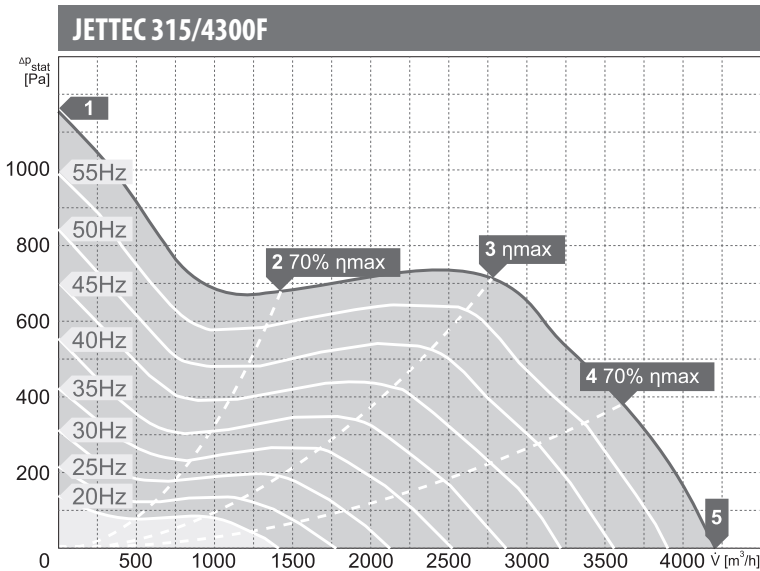
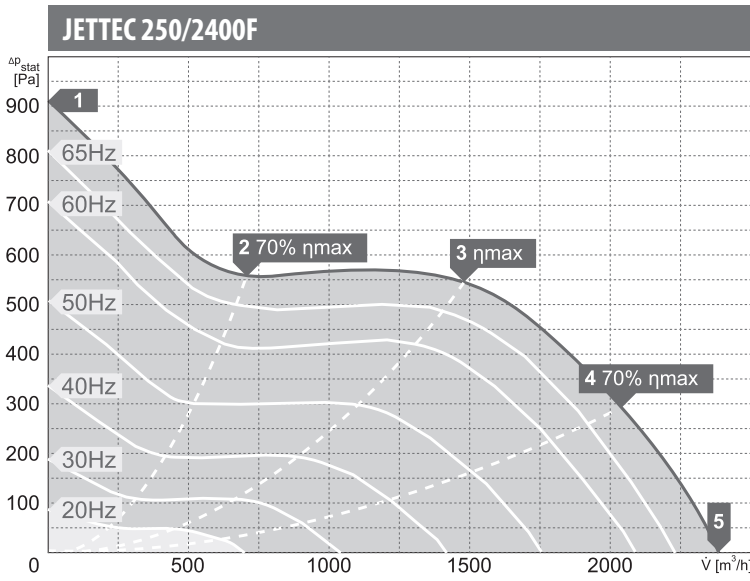

wartości mocy akustycznej L_{WA} [dB(A)]
dla poszczególnych częstotliwości pasm oktaowych [Hz]

Pkt. Pracy	Częstotliwości pasm oktaowych [Hz]								
	tot	63	125	250	500	1000	2000	4000	8000
L_{WA} wlot [dB(A)]									
2	83	51	65	69	77	78	76	75	66
3	79	44	48	58	70	73	74	73	66
4	81	41	45	55	71	74	76	78	70
5	84	40	47	58	74	76	78	79	73
L_{WA} wylot [dB(A)]									
2	86	50	66	70	78	83	80	75	68
3	82	43	51	61	73	78	77	73	65
4	82	37	44	56	70	77	77	76	67
5	86	35	47	60	75	82	80	79	73
L_{WA} od obudowy [dB(A)]									
2	68	48	53	54	55	62	62	63	49
3	65	52	37	45	48	56	58	63	47
4	65	49	36	44	47	56	59	63	49
5	67	49	38	47	53	61	62	63	54

Pkt. Pracy	Częstotliwości pasm oktaowych [Hz]								
	tot	63	125	250	500	1000	2000	4000	8000
L_{WA} wlot [dB(A)]									
2	84	-	59	71	76	79	78	75	70
3	79	-	44	59	70	74	73	71	70
4	81	-	46	60	72	76	75	73	73
5	86	-	56	63	76	81	79	79	78
L_{WA} wylot [dB(A)]									
2	90	-	65	75	82	87	84	78	71
3	87	-	52	67	78	85	81	74	68
4	89	-	54	68	79	87	82	76	70
5	92	-	54	69	82	90	85	79	73
L_{WA} od obudowy [dB(A)]									
2	73	-	58	56	64	69	64	61	53
3	70	-	49	49	64	67	60	59	51
4	72	-	50	51	66	68	63	61	54
5	75	10	52	52	68	73	66	64	56

Pkt. Pracy	Częstotliwości pasm oktaowych [Hz]								
	tot	63	125	250	500	1000	2000	4000	8000
L_{WA} wlot [dB(A)]									
2	86	-	61	75	78	81	80	77	70
3	81	-	49	70	72	76	75	73	67
4	82	-	48	72	73	77	77	75	69
5	86	-	51	75	77	80	80	80	73
L_{WA} wylot [dB(A)]									
2	90	-	68	77	84	86	82	77	68
3	85	-	55	73	80	82	79	74	66
4	87	-	52	75	81	82	80	76	68
5	91	-	54	77	85	86	84	81	73
L_{WA} od obudowy [dB(A)]									
2	72	-	60	59	68	68	63	60	48
3	67	-	53	57	60	63	59	58	48
4	70	-	50	57	65	65	61	60	50
5	73	-	48	58	68	68	65	63	52

charakterystyki pracy

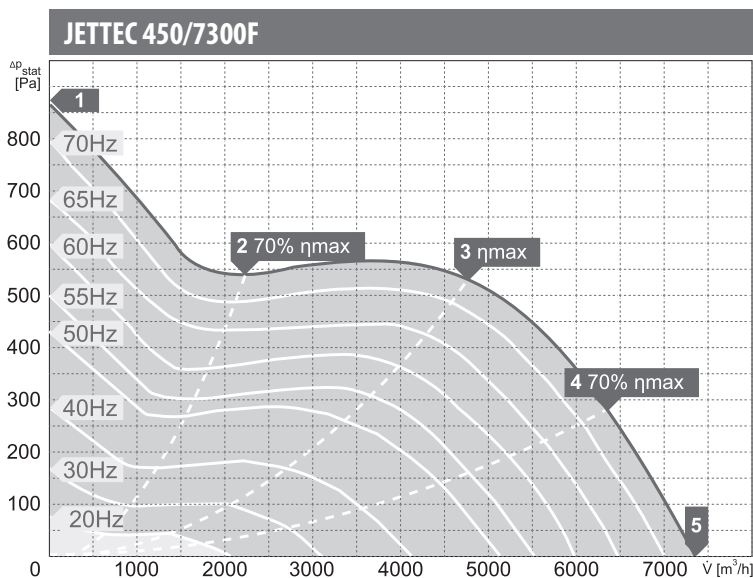
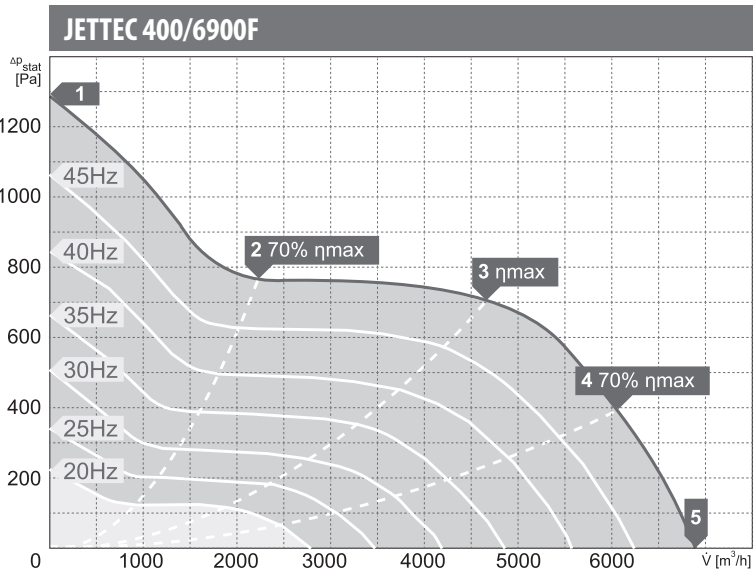
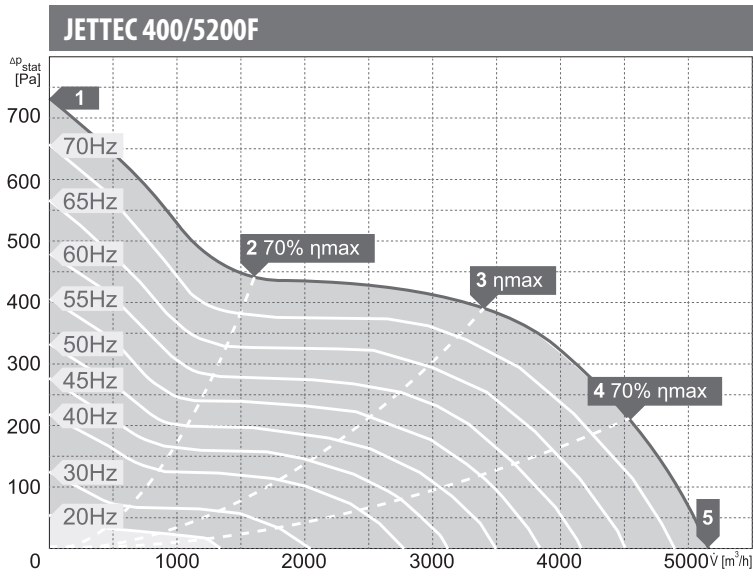

wartości mocy akustycznej L_{WA} [dB(A)]
dla poszczególnych częstotliwości pasm oktaowych [Hz]

Pkt. Pracy	tot	Częstotliwości pasm oktaowych [Hz]							
		63	125	250	500	1000	2000	4000	8000
L_{WA} wlot [dB(A)]									
2	88	81	83	81	78	75	69	61	45
3	80	66	76	74	72	72	67	61	47
4	84	67	81	77	76	76	73	65	51
5	85	68	82	77	77	77	74	66	52
L_{WA} wylot [dB(A)]									
2	91	84	84	86	82	77	72	64	47
3	86	69	81	82	80	74	70	63	49
4	90	69	85	85	83	78	75	67	53
5	90	69	85	86	84	79	76	68	53
L_{WA} od obudowy [dB(A)]									
2	77	76	61	68	67	61	57	49	27
3	68	58	57	64	63	58	56	49	28
4	71	57	58	67	65	61	59	51	30
5	71	59	59	68	66	62	60	51	31

Pkt. Pracy	tot	Częstotliwości pasm oktaowych [Hz]							
		63	125	250	500	1000	2000	4000	8000
L_{WA} wlot [dB(A)]									
2	91	-	71	82	85	86	85	80	70
3	87	-	61	78	79	81	83	78	69
4	89	17	57	80	81	83	85	81	75
5	91	-	58	82	81	84	86	83	80
L_{WA} wylot [dB(A)]									
2	96	-	77	82	91	91	87	83	74
3	93	-	65	79	89	88	85	82	73
4	94	15	60	80	90	90	87	84	76
5	95	-	61	82	90	91	88	85	80
L_{WA} od obudowy [dB(A)]									
2	83	-	65	78	76	77	72	69	59
3	82	-	56	80	76	75	70	68	59
4	83	12	55	81	77	74	70	69	60
5	84	10	56	81	77	75	72	71	62

Pkt. Pracy	tot	Częstotliwości pasm oktaowych [Hz]							
		63	125	250	500	1000	2000	4000	8000
L_{WA} wlot [dB(A)]									
2	89	84	85	82	79	76	71	63	47
3	82	67	78	76	73	73	70	64	49
4	87	70	84	80	78	78	76	68	54
5	88	72	84	81	79	78	77	69	54
L_{WA} wylot [dB(A)]									
2	93	87	85	89	84	79	76	68	51
3	87	73	82	83	79	75	72	65	51
4	91	72	85	87	83	79	77	70	55
5	92	74	87	88	84	81	78	71	57
L_{WA} od obudowy [dB(A)]									
2	81	78	74	74	70	63	60	49	30
3	72	62	65	68	64	57	57	47	30
4	74	62	67	70	66	62	61	50	32
5	75	64	69	72	68	63	62	51	33

charakterystyki pracy

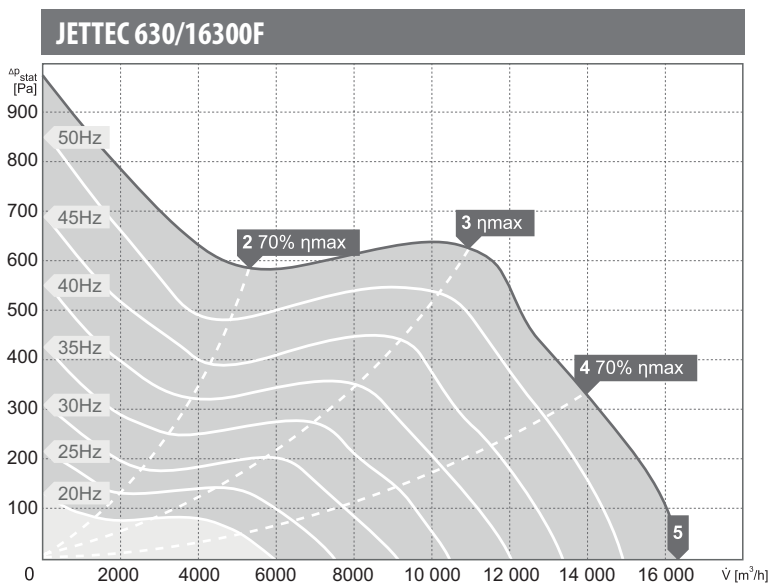
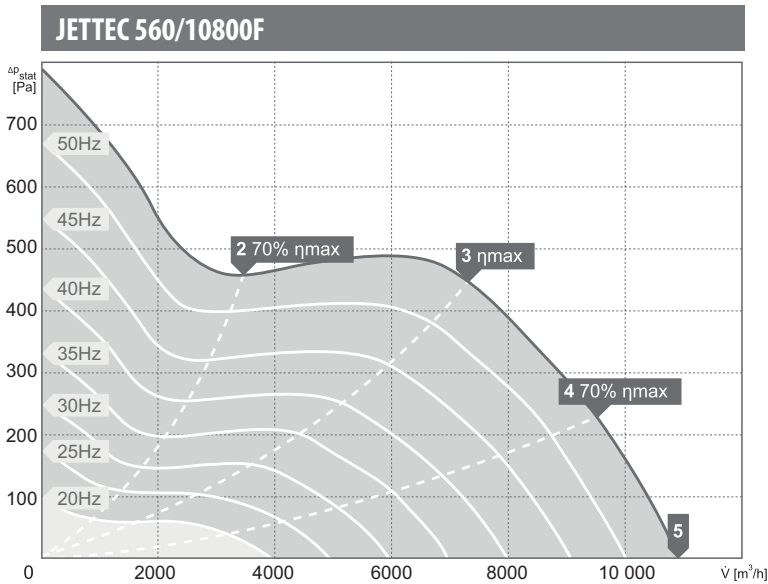
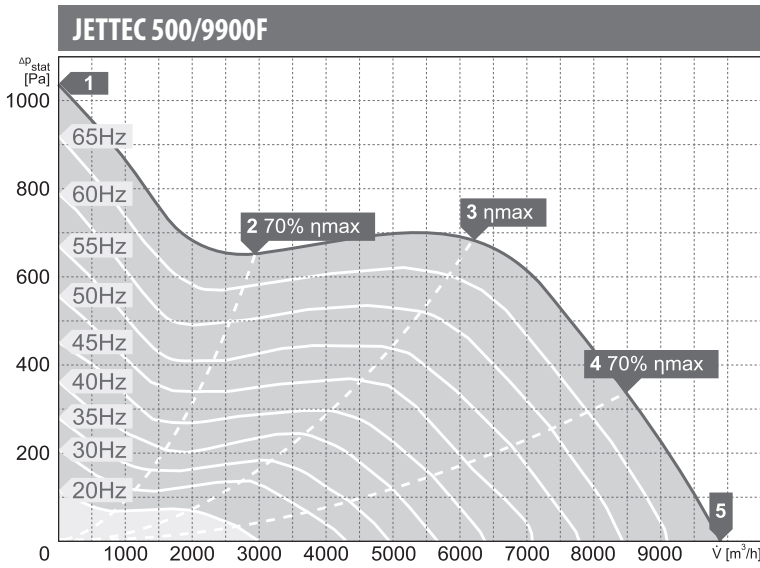

wartości mocy akustycznej L_{WA} [dB(A)]
dla poszczególnych częstotliwości pasm oktaowych [Hz]

Pkt. Pracy	Częstotliwości pasm oktaowych [Hz]								
	tot	63	125	250	500	1000	2000	4000	8000
L_{WA} wlot [dB(A)]									
2	90	77	82	85	85	83	78	70	61
3	83	56	73	77	77	75	73	65	57
4	86	58	77	81	81	79	78	69	58
5	88	61	80	82	83	81	79	72	62
L_{WA} wylot [dB(A)]									
2	94	79	82	90	88	85	81	72	62
3	93	73	81	88	89	85	80	72	61
4	93	72	81	88	89	85	81	73	62
5	94	71	81	89	89	86	82	74	63
L_{WA} od obudowy [dB(A)]									
2	85	78	77	82	76	71	66	60	47
3	79	70	76	73	69	63	63	58	46
4	81	72	77	76	70	66	65	58	46
5	84	77	77	79	75	70	68	61	49

Pkt. Pracy	Częstotliwości pasm oktaowych [Hz]								
	tot	63	125	250	500	1000	2000	4000	8000
L_{WA} wlot [dB(A)]									
2	87	60	74	79	82	82	80	74	64
3	85	55	69	75	80	80	77	71	61
4	86	42	66	75	80	81	78	75	64
5	88	43	68	77	82	83	82	79	67
L_{WA} wylot [dB(A)]									
2	90	58	74	80	86	84	81	75	65
3	86	45	68	76	82	80	77	72	63
4	86	44	67	77	82	80	78	74	64
5	90	46	70	80	86	84	82	79	69
L_{WA} od obudowy [dB(A)]									
2	81	61	64	70	78	74	71	65	54
3	78	50	59	69	75	71	67	61	52
4	77	42	60	68	74	71	68	65	54
5	81	43	58	69	78	75	73	68	58

Pkt. Pracy	Częstotliwości pasm oktaowych [Hz]								
	tot	63	125	250	500	1000	2000	4000	8000
L_{WA} wlot [dB(A)]									
2	90	64	76	81	86	85	83	76	67
3	85	42	65	74	80	80	77	74	63
4	88	43	69	77	82	82	80	79	73
5	91	46	72	80	85	85	83	81	75
L_{WA} wylot [dB(A)]									
2	94	67	79	85	90	89	86	79	69
3	89	45	68	77	85	83	79	75	64
4	91	45	69	79	87	85	82	79	70
5	95	49	74	83	90	89	86	82	75
L_{WA} od obudowy [dB(A)]									
2	82	67	66	71	80	74	71	62	55
3	77	45	56	66	73	72	67	62	51
4	79	44	58	68	76	74	70	66	56
5	83	48	63	72	79	77	74	69	63

charakterystyki pracy

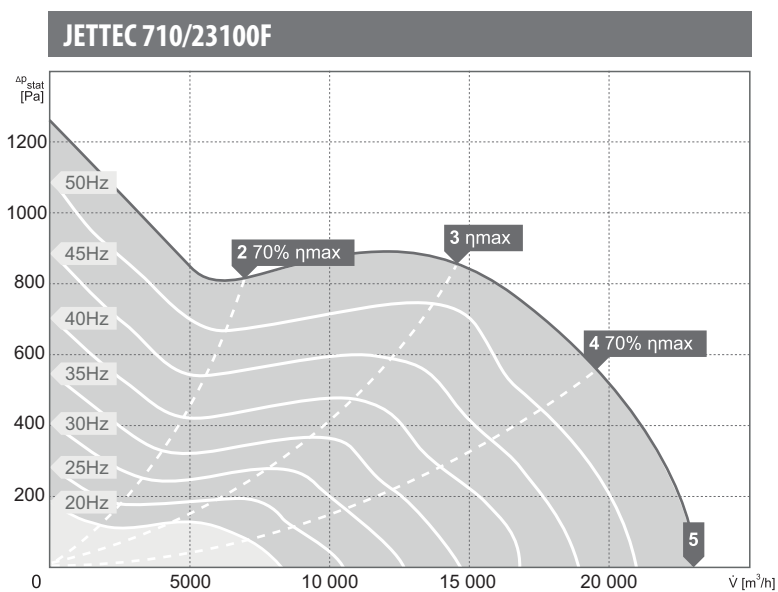

wartości mocy akustycznej L_{WA} [dB(A)]
dla poszczególnych częstotliwości pasm oktaowych [Hz]

Pkt. Pracy	tot	Częstotliwości pasm oktaowych [Hz]							
		63	125	250	500	1000	2000	4000	8000
L_{WA} wlot [dB(A)]									
2	97	71	82	88	92	91	89	84	74
3	94	55	75	83	89	88	86	84	74
4	94	53	74	83	89	89	86	85	76
5	95	54	75	85	90	90	87	86	79
L_{WA} wylot [dB(A)]									
2	99	69	80	88	95	93	91	86	76
3	96	51	72	84	92	90	88	84	75
4	97	52	73	85	93	91	89	86	77
5	98	54	75	86	94	93	90	87	79
L_{WA} od obudowy [dB(A)]									
2	89	71	73	81	87	80	79	69	63
3	85	52	67	76	83	77	76	68	61
4	87	51	68	78	85	78	77	70	64
5	89	53	70	80	87	81	79	72	67